

IVC1-2DA Analog Output Module

User Manual

Note:

To reduce the chance of accident, please carefully read the operating instructions and safety precautions prior to use. Only adequately trained personnel shall install or operate this product. In operation, strict compliance with applicable safety rules in the industry, the operating instructions and safety precautions in this book is required.

1 Port Description

1.1 Port

The extension port and user port of IVC1-2DA are both protected by a cover, as shown in Figure 1-1.

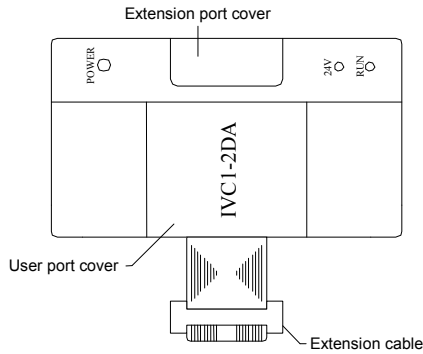

Figure 1-1 IVC1-2DA appearance

Removing the covers reveals the extension port and user port, as shown in Figure 1-2.

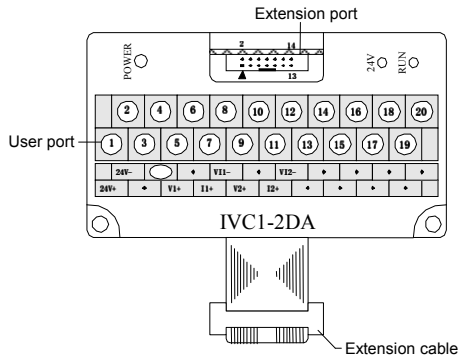

Figure 1-2 IVC1-2DA ports

The extension cable connects IVC1-2DA to the system, while the extension port connects IVC1-2DA to another extension module of the system. For details, see section 1.2 *Connecting Into System*.

The user port of IVC1-2DA is described in Table 1-1.

Table 1-1 User port description

Terminal	Name	Description
1	24V+	Analog power supply 24V+
2	24V-	Analog power supply 24V-
4		GND
5, 9	V1+, V2+	Voltage output of CH1 ~ CH2
7, 11	I1+, I2+	Current output of CH1 ~ CH2
8, 12	VI1-, VI2-	Common GND of CH1 ~ CH2
3, 6, 10, 13 ~ 20	•	NC

1.2 Connecting Into System

Through the extension cable, you can connect IVC1-2DA to IVC1 series PLC basic module or other extension module. You can also connect another IVC1 series extension module to IVC1-2DA through the extension port. See Figure 1-3.

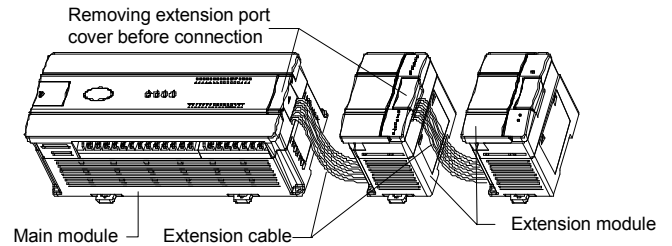

Figure 1-3 Connecting into system

1.3 Wiring

Figure 1-4 shows the wiring of the user port.

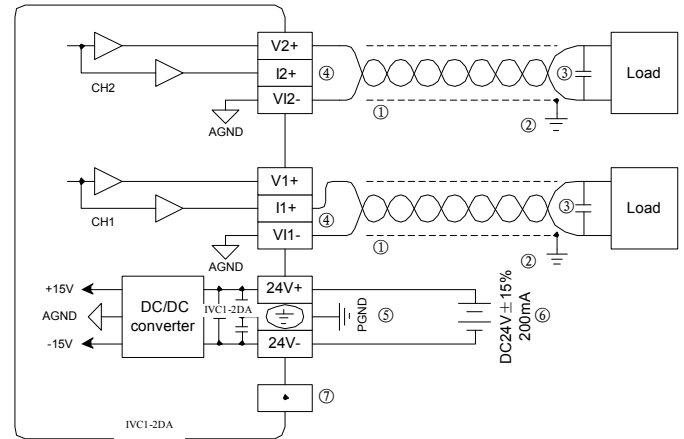

Figure 1-4 Wiring of IVC1-2DA user port

The circled 1~7 stands for the seven points to be observed during wiring.

1. It is recommended to use shielded twisted pair as the analog output cable. Route them separate from power cables or any cable that may generate EMI.
2. Each load of the PLC should be grounded separately.
3. If voltage fluctuation or EMI is present at the output, it is advisable to connect a smoothing capacitor (0.1 μ F~0.47 μ F/25V)
4. IVC1-2DA may be damaged if the voltage output is shorted, or if a current load is connected to a voltage output terminal.
5. Properly ground the module PG terminal.
6. The 24Vdc power from basic module or any qualified external power supply can be used as the module power source.
7. Do not use the NC terminals of the user port.

2 Indices

2.1 Power Supply

Table 2-1 Power supply

Item	Description
Analog circuit	24Vdc (-15%~+20%), maximum allowable ripple voltage 5%, 120mA (from basic module or external power supply)
Digital circuit	5Vdc 50 mA (from basic module)

2.2 Performance

Table 2-2 Performance

Item	Specification
Conversion speed	2ms/channel (changing channel number will not change conversion speed)
Analog output	Voltage: -10 ~ +10Vdc (external load impedance $\geq 2k\Omega$)
	Current: 0 ~ 20mA (external load impedance $\leq 520\Omega$)
Digital input	Default: -2000 ~ +2000 Setting range: -10,000 ~ +10,000
Resolution	Voltage: 5mV
	Current: 10 μ A
Accuracy	$\pm 1\%$ of full range
Isolation	Between analog circuit and digital circuit: PhotoCoupler. Between analog circuit and external power supply: DC/DC converter. Between analog channels: none

2.3 Buffer Memory

IVC1-2DA exchanges data with the basic module through Buffer Memory (BFM). After IVC1-2DA is set through the host software, the basic module will write data into IVC1-2DA BFM to set the state of IVC1-4TC, and display the data from IVC1-2DA on the host software interface. See figures 4-1 ~ 4-4.

Table 2-3 describes the contents of the BFM of IVC1-2DA.

Table 2-3 BFM contents

BFM	Contents	Default	Property
#000	CH1 output data		RW
#001	CH2 output data		RW
#300	Module error state word		R
#650	Channel mode word	Default: 0x0000	RW
#900	CH1-D0	Default: 0 (output mode 0)	RW
#901	CH1-A0	Default: 0 (output mode 0)	R
#902	CH1-D1	Default: 2000 (output mode 0)	RW
#903	CH1-A1	Default: 10000 (output mode 0)	R
#904	CH2-D0	Default: 0 (output mode 0)	RW
#905	CH2-A0	Default: 0 (output mode 0)	R
#906	CH2-D1	Default: 2000 (output mode 0)	RW
#907	CH2-A1	Default: 10000 (output mode 0)	R
#2100	Channel reset command	Default: 0x0000	RW
#4094	Module software version information	0x1000	R
#4095	Module ID	0x2201	R

Note:

- CH1 stands for channel 1; CH2, channel 2.
- Property explanation: R means read only. An R element cannot be written. RW means read and write. Reading from a non-existent element will get 0.
- Table 2-4 shows the BFM#300 status information.

Table 2-4 BFM#300 status information

Bit status of BFM#300	ON (1)	OFF (0)
b0: error	b1 or b2 is ON	No error
b2: power failure	24Vdc power supply failure	Power supply normal

- BFM#650: output mode selection, used to set the output modes of CH1 ~ CH2. See Figure 2-1 for their correspondence.

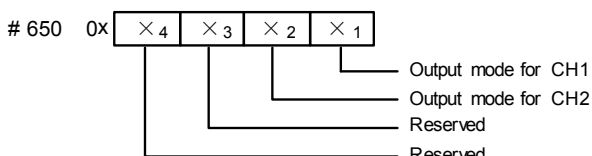

Figure 2-1 Mode setting element vs. channel

The exact correspondence between BFM#650 value and output mode is

shown in Table 2-5.

Table 2-5 BFM#650 value vs. output mode

Value of X	Mode
0	-10V ~ +10V voltage output
1	0 ~ 20mA current output
2	4 ~ 20mA current output
3	Reserved

Note: When the output mode is set as 2, the corresponding channel output characteristic setting D0 (explained in the following note 5) will change automatically, and maintain that value when this channel is set to other modes later. In that case, you need to change D0 as per actual needs. See the following note 5 for details.

5. BFM#900 ~ BFM#907: channel output characteristic setting. Use two points to set the channel characteristic. D0 and D1 stands for digital output, while A0 and A1 stands for actual output, in the unit of mV or μ A. Each channel occupies four words. To simplify the operation process without affecting functions, A0 and A1 are respectively fixed to analog 0 and the maximum value. When BFM#650 (channel mode) is changed, A0 and A1 will change accordingly. Users cannot change their values.

6. BFM#2100: channel resetting command. When the PLC is in STOP mode, the last output values in its RUN state will be hold. To reset those values into deviation, you can write the hexadecimal number $HX_4X_3X_2X_1$ into BFM#2100, where X1 is the setting for CH1, X2 is for CH2. When X is 0, the output will be hold. When X is 1, the output will be reset to the deviation.

7. BFM#4094: module software version information, displayed automatically as **Module Version** in **IVC1-2DA Configuration** dialogue box of the host software, as shown in Figure 4-2.

8. BFM#4095: module ID. The ID of IVC1-2DA is 0x2201. The PLC user program can sue this code to identify the module before transceiving data.

3 Characteristic Setting

The input channel characteristic of IVC1-2DA is the linear relationship between the channel's digital output D and analog output A. It can be set by the user. Each channel can be considered as the model shown in Figure 3-1. As it is of linear characteristic, the channel characteristic can be defined by just two points: P0 (A0, D0) and P1 (A1, D1), where D0 is the channel's digital input corresponding to analog output A0, and D1 is the channel's digital input corresponding to analog output A1.

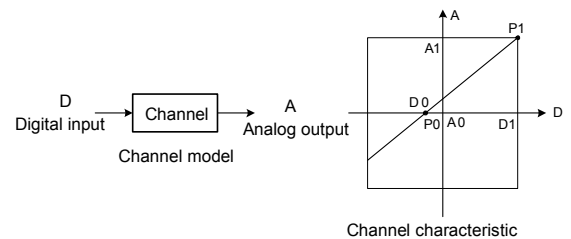

Figure 3-1 IVC1-2DA characteristic setting

To simplify the operation process without affecting functions, A0 and A1 are respectively fixed to analog 0 and the maximum value in the present mode. That means in Figure 3-1, the A0 is 0, A1 is the maximum analog output in the present mode. When BFM#650 (channel mode) is changed, A0 and A1 will change accordingly. Users cannot change their values.

If you set the channel mode without changing D0 and D1, the channel characteristics vs. modes should be as shown in Figure 3-2.

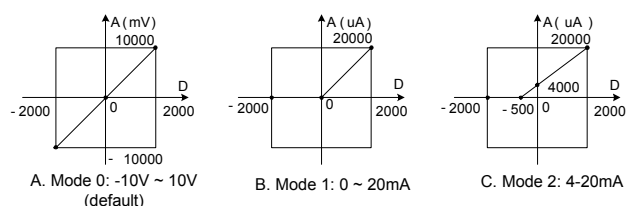

Figure 3-2 Characteristics vs. modes without changing D0 and D1

You can change the channel characteristics by changing D0 and D1, whose setting ranges are both -10000 ~ 10000. If the setting is outside this range,

5 Operation Inspection

5.1 Routine Inspection

1. Check that the wiring of analog output meets the requirements (see 1.3 wiring).
2. Check that the extension cable of IVC1-2DA is properly inserted in the extension port.
3. Check that the 5V and 24V power supplies are not overloaded. Note: The digital circuit is powered by the basic module through extension cable.
4. Check the application and make sure the operation method and parameter range are correct.
5. Set the IVC1 basic module to RUN state.

5.2 Inspection Upon Fault

- In case of abnormality, check the following items:
- The status of the POWER indicator
 - ON: the extension cable is properly connected
 - OFF: Check the extension cable connection and the basic module.
 - The wiring of analog input
 - The status of the 24V indicator
 - ON: 24Vdc power supply normal
 - OFF: 24Vdc power supply possibly faulty, or IVC1-2DA faulty
 - The status of the RUN indicator

Flash quickly: IVC1-2DA in normal operation
Flash slowly or OFF: Check the **Error Status** in **IVC1-2DA Configuration** dialogue box through the host software.

Notice

1. The warranty range is confined to the PLC only.
 2. **Warranty period is 18 months**, within which period INVT Auto-control Technology Co. Ltd. conducts free maintenance and repairing to the PLC that has any fault or damage under the normal operation conditions.
 3. **The start time of warranty period is the delivery date of the product**, of which the product SN is the sole basis of judgment. PLC without a product SN shall be regarded as out of warranty.
 4. Even within 18 months, maintenance will also be charged in the following situations:
 - Damages incurred to the PLC due to mis-operations, which are not in compliance with the User Manual;
 - Damages incurred to the PLC due to fire, flood, abnormal voltage, etc;
 5. The service fee will be charged according to the actual costs. If there is any contract, the contract prevails.
 6. Please keep this paper and show this paper to the maintenance unit when the product needs to be repaired.
 7. If you have any question, please contact the distributor or our company directly.
- Shenzhen INVT Auto-control Technology Co., Ltd.
Address: Gaofa Industry Park, Longjing, Nanshan District 518055, Shenzhen China
Homepage: www.invt-control.com
- Version V1.0
Revision date February 15, 2012
All rights reserved. The contents in this document are subject to change without notice.

IVC1-2DA will not accept it, but maintain the original valid setting. Figure 3-3 gives you an example of changing characteristics.

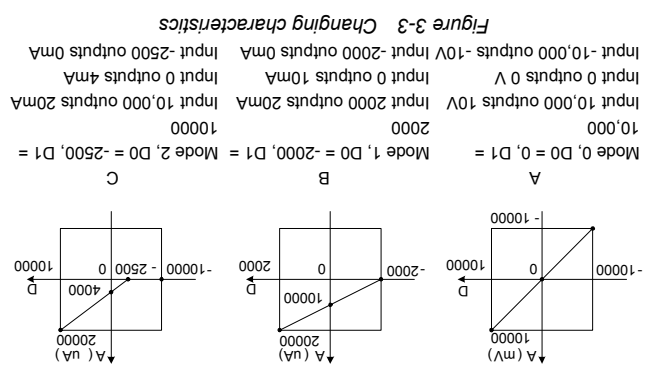

4 Application Example

4.1 Basic Application

Example: Set IVC1-2DA CH1 to mode 0 (-10V ~ 10V), set CH2 to mode 2 (4 ~ 20mA).
 Set as per the following: CH1: saw-tooth wave voltage output -10V ~ 10V, use variant D1. CH2: 7.2mA current output, use variant D2.
 The channel setting interface is as follows:

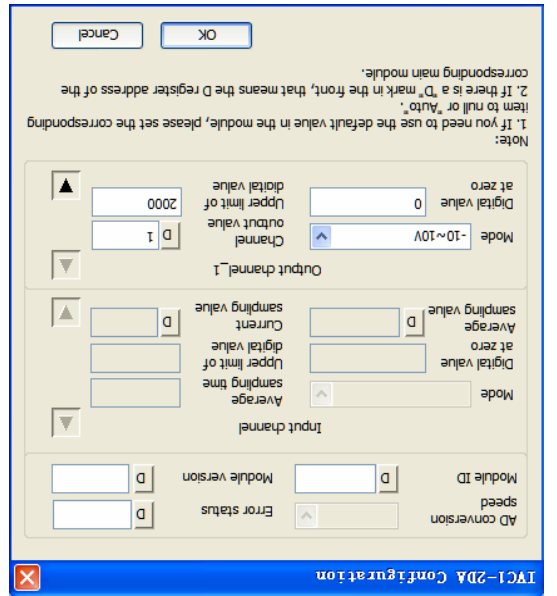

Figure 4-1 Channel 1 configuration

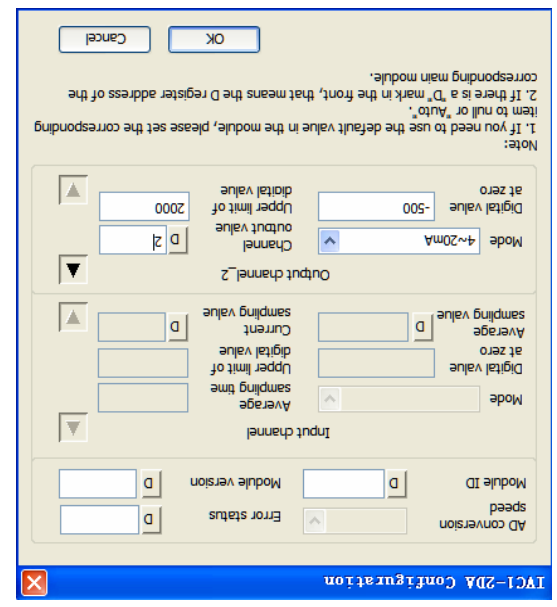
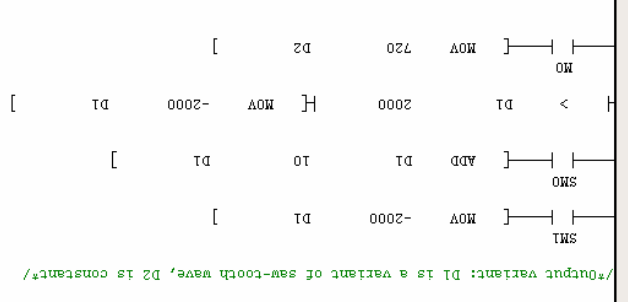

Figure 4-2 Channel 2 configuration

4.2 Changing Characteristics

Example: Change the characteristics of IVC1-2DA CH1 and CH2 according to the A and B modes in Figure 3-3. CH1 (mode 0) outputs a -2V ~ +2V saw-tooth wave, with the step time being the system scan time. CH2 (mode 1) outputs 15mA current.
 The channel characteristic setting is shown in figures 4-2 ~ 4-4. For details, see IVC Series Small PLC Programming Manual.



The user program is as follows:

4.2 Changing Characteristics

Example: Change the characteristics of IVC1-2DA CH1 and CH2 according to the A and B modes in Figure 3-3. CH1 (mode 0) outputs a -2V ~ +2V saw-tooth wave, with the step time being the system scan time. CH2 (mode 1) outputs 15mA current.
 The channel characteristic setting is shown in figures 4-2 ~ 4-4. For details, see IVC Series Small PLC Programming Manual.

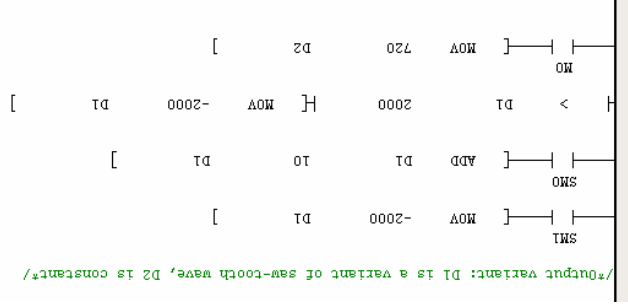

The user program is as follows:

4.2 Changing Characteristics

Example: Change the characteristics of IVC1-2DA CH1 and CH2 according to the A and B modes in Figure 3-3. CH1 (mode 0) outputs a -2V ~ +2V saw-tooth wave, with the step time being the system scan time. CH2 (mode 1) outputs 15mA current.

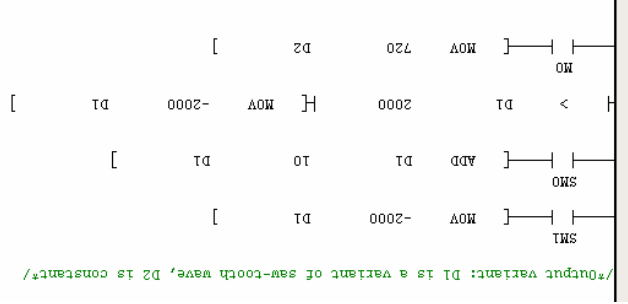

The user program is as follows:

4.2 Changing Characteristics

Example: Set IVC1-2DA CH1 to mode 0 (-10V ~ 10V), set CH2 to mode 2 (4 ~ 20mA).
 Set as per the following: CH1: saw-tooth wave voltage output -10V ~ 10V, use variant D1. CH2: 7.2mA current output, use variant D2.
 The channel setting interface is as follows:

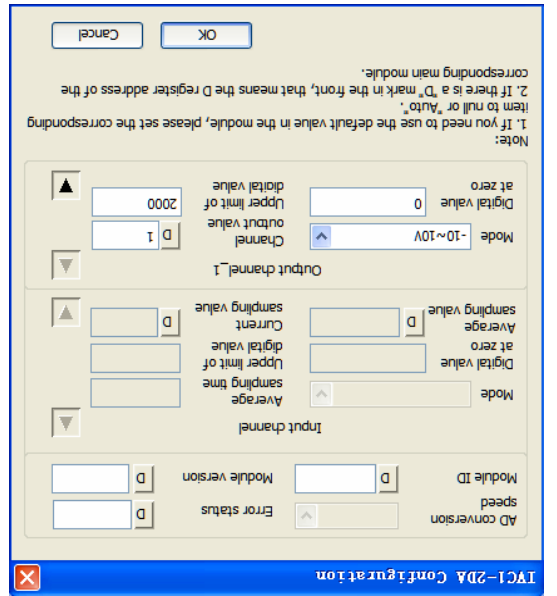

Figure 4-1 Channel 1 configuration

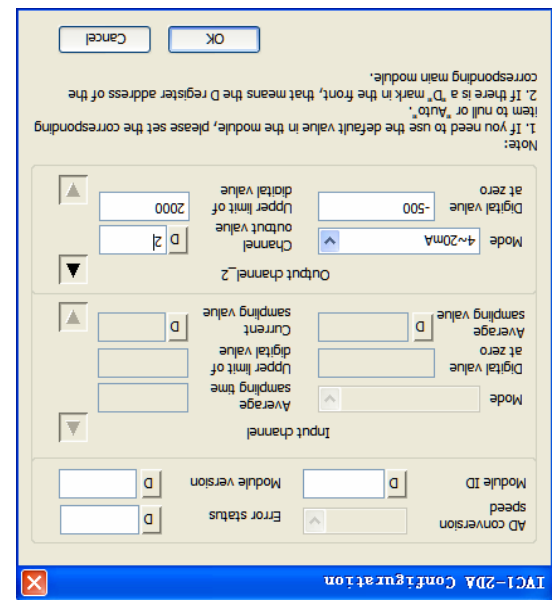

Figure 4-2 Channel 2 configuration

4.2 Changing Characteristics

Example: Set IVC1-2DA CH1 to mode 0 (-10V ~ 10V), set CH2 to mode 2 (4 ~ 20mA).
 Set as per the following: CH1: saw-tooth wave voltage output -10V ~ 10V, use variant D1. CH2: 7.2mA current output, use variant D2.
 The channel setting interface is as follows:

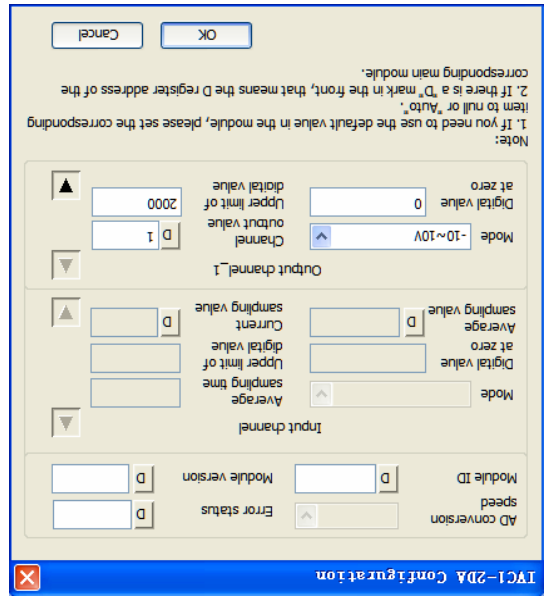

Figure 4-1 Channel 1 configuration

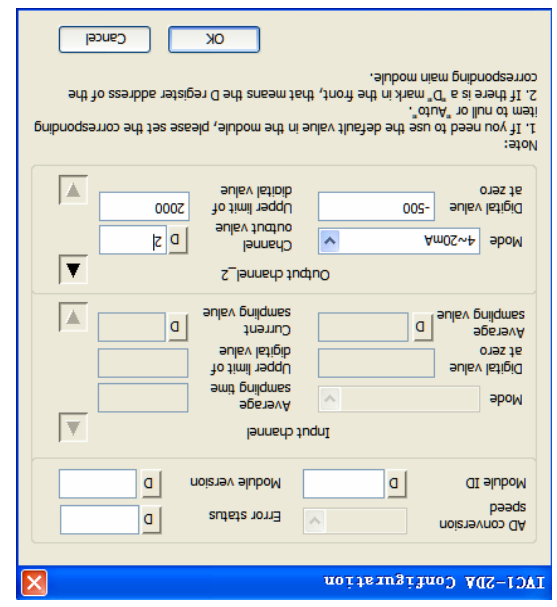

Figure 4-2 Channel 2 configuration

4.2 Changing Characteristics

Example: Set IVC1-2DA CH1 to mode 0 (-10V ~ 10V), set CH2 to mode 2 (4 ~ 20mA).
 Set as per the following: CH1: saw-tooth wave voltage output -10V ~ 10V, use variant D1. CH2: 7.2mA current output, use variant D2.
 The channel setting interface is as follows:

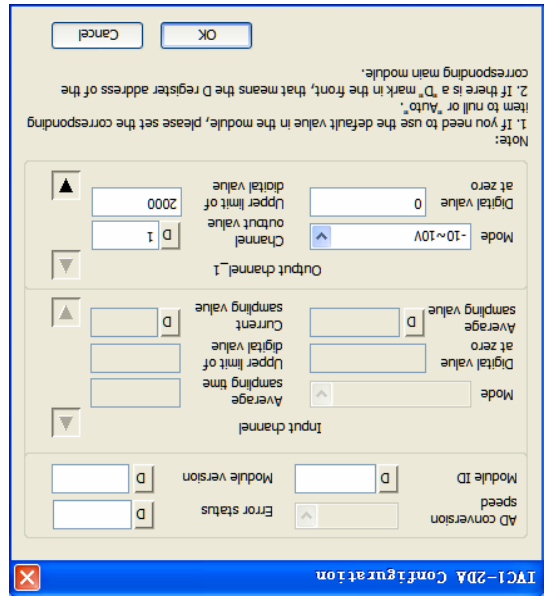

Figure 4-1 Channel 1 configuration

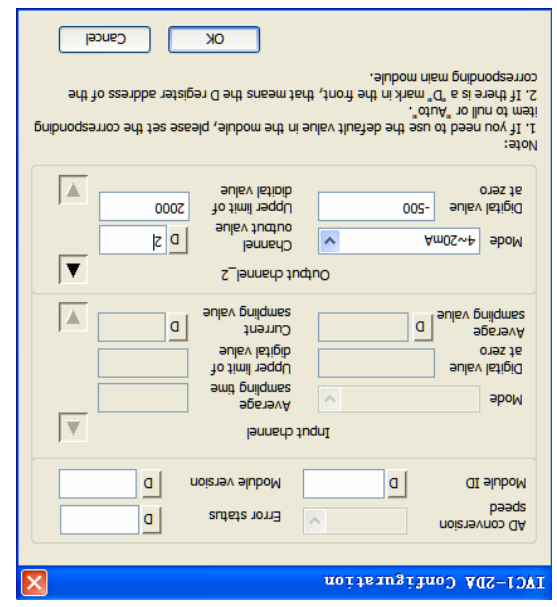

Figure 4-2 Channel 2 configuration

4.2 Changing Characteristics

Example: Set IVC1-2DA CH1 to mode 0 (-10V ~ 10V), set CH2 to mode 2 (4 ~ 20mA).
 Set as per the following: CH1: saw-tooth wave voltage output -10V ~ 10V, use variant D1. CH2: 7.2mA current output, use variant D2.
 The channel setting interface is as follows:

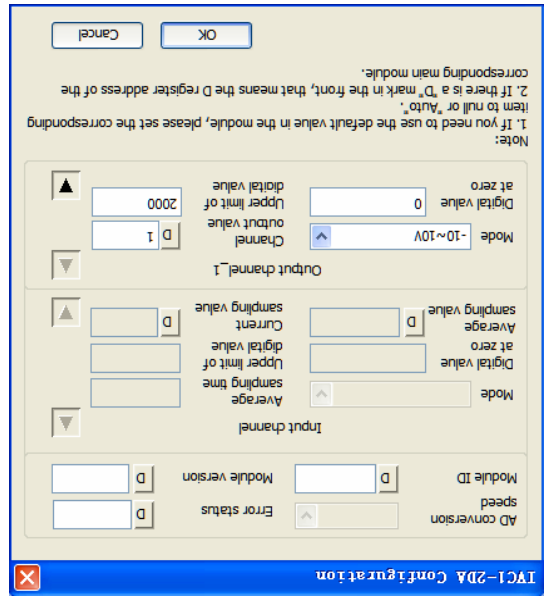

Figure 4-1 Channel 1 configuration

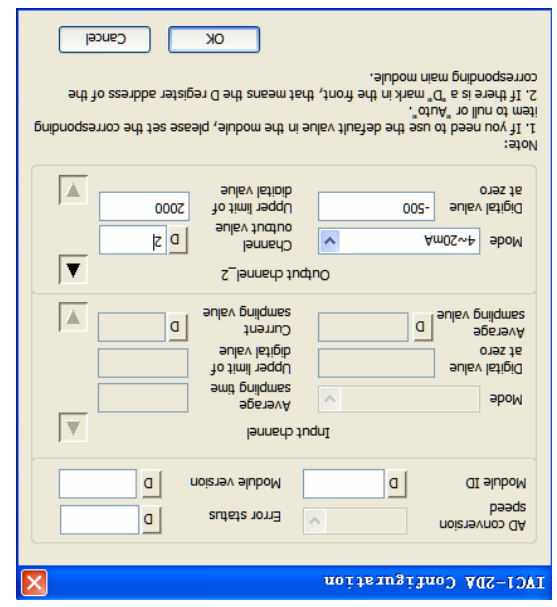

Figure 4-2 Channel 2 configuration