

CHV Series Vector Control Inverter Options

Operating Instructions for External LCD Keypad

Table of Contents

1.	Description of Operation Panel	3
1.1.	Schematic Diagram of the Panel.....	3
1.2.	Functions of Keys.....	3
1.3.	Description of Indicators.....	4
2.	Operation Instructions	5
2.1	Functions and Features.....	5
2.2	Display Steps.....	6
2.3	Display Contents in Different States	6
2.3.1	Stop State Interface.....	6
2.3.2	Level-1 Menu Interface.....	7
2.3.3	Level-2 Menu Interface.....	7
2.3.4	Level-3 Menu Interface.....	8
2.3.5	Fault Status Interface	9
2.3.6	Shortcut Menu Interface	9
3.	LCD Screen Contrast Adjustment.....	9
4.	Installation Dimensions of External LCD Keypad.....	10

1. Description of Operation Panel

1.1. Schematic Diagram of the Panel

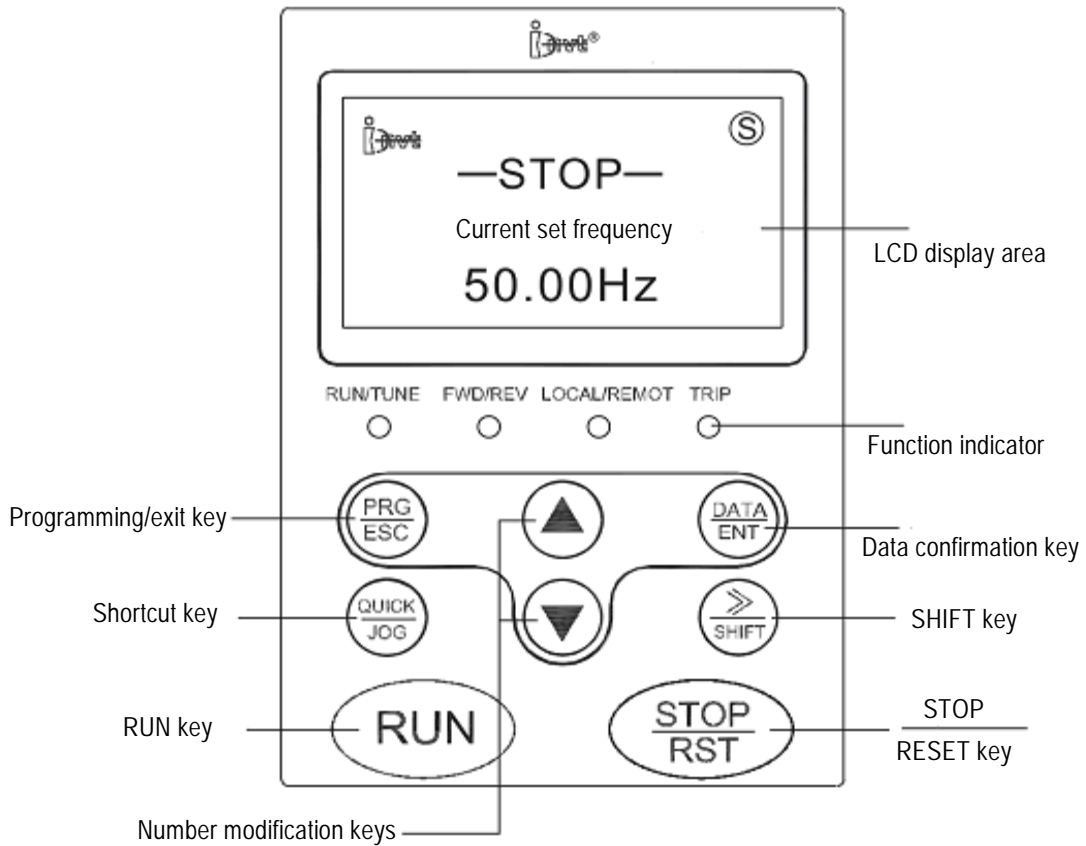











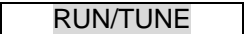



Figure 1-1 Schematic Diagram of the Operation Panel

1.2. Functions of Keys

Key Symbol	Name	Function Description
	Programming/E SC key	Enters or exits the level-1 menu; deletes shortcut parameter
	Confirmation key	Enters menus level by level; conforms parameter setting
	UP key	Increase of data or functional code
	DOWN key	Decrease of data or functional code

Key Symbol	Name	Function Description
	SHIFT key	Displays parameters cyclically in the stop display interface and operation display interface; select the bit to be modified when modifying a parameter
	RUN key	Used for operation in keypad operation mode
	STOP/RESET key	In operation mode, press this key to stop the operation; restricted by the functional code P7.04. In fault alarm state, press this key to reset any control mode.
	Multifunctional shortcut key	Function of this key is determined by the functional code P7.03: 0: Quick function of shortcut menus; enters or exits level-1 menu. 1: Switching between forward rotation and reverse rotation; the changeover key 2. JOG operation, forward rotation JOG key 3. Clearing UP/DOWN settings: Clears frequency values set by UP/DOWN keys
	Combination	Press the <RUN> key and the <STOP/RST> key at the same time, the inverter free stops

1.3. Description of Indicators

Indicator	Indication
	If the indicator is off, it indicates the inverter stops; if the indicator flickers, it indicates the inverter is in the parameter self-learning state; if the indicator is on, it indicates the inverter is in the operation state;
	Forward/Reverse rotation indicator: If the indicator is off, it means the inverter is in the forward rotation state; if the indicator is on, it means the inverter is in the reverse rotation state.
	Keypad operation, terminal operation, and remote communication control indicator: If the indicator is off, it indicates the inverter is in the keypad operation control mode; if the indicator flickers, it indicates the inverter is in the operation control state; if the indicator is on, it indicates the inverter is in the remote operation control state.
	Overload alarm indicator: If it is in the overload alarm state, the indicator flickers; otherwise, the indicator is off.

2. Operation Instructions

2.1 Functions and Features

The external LCD keypad aims to provide users with explanations for functional parameters to help them get a better understanding. When a user does not know specific meanings of a functional code, the external LCD keypad can display the meaning of the code visually. This keypad can be connected to any one of the inverters developed by Shenzhen INVT Electric Co., Ltd. The inverters are fully compatible with the operations of the external LED keypad designed by INVT. When an external keypad is connected to the system, the system can automatically recognize the keypad and, at the same time, shut down the keypad display of the system.

In the operation and stop status, the external LCD keypad can display three parameters at the same time, so that the user can know the comparison between parameters. In the operation, stop and fault state, the LCD displays flicking small icons, which enable the user to know the current state of the inverter and to have a better understanding of the working state of the control chip.

In addition, functional parameter copying function is added, which enables the user to set the parameters of multiple inverters to same values. If it is necessary to maintain consistent parameter settings for several motors, the user only has to set parameters on one motor, uploads the settings, and then downloads functional parameter settings to other inverters. In this way, parameter settings of multiple inverters are consistent. As a result, it is unnecessary to set functional parameters for each inverter.

During parameter uploading and downloading, read-only parameters, user password, and local communication address cannot be copied.

Note:

- 1) **Since LED and the external LCD keypad shares the same port, the external LCD keypad and the keypad of the local equipment cannot run concurrently (Set P7.05 to 0: priority given to external keypad).**

During the use of the external LCD keypad, P7.05 can only be set to 0 to prevent maloperation. If the user enters the external LCD keypad from a different keypad mode, it is required to set P7.05 to 0; otherwise, it cannot display normally.

- 2) **Parameter uploading and downloading operation can be performed only for the same series of inverters. The user shall be liable for any damage to or fault with inverters if the user, against such this requirement, transfers parameters among inverters of different brands or series.**

2.2 Display Steps

When the external LCD keypad is powered on, the display screen begins the initialization process and displays the company logo. This process will take about 5 seconds. When everything is normal, the LCD keypad enters the stop display interface. The user can then operate through the LCD keypad.

2.3 Display Contents in Different States

2.3.1 Stop State Interface

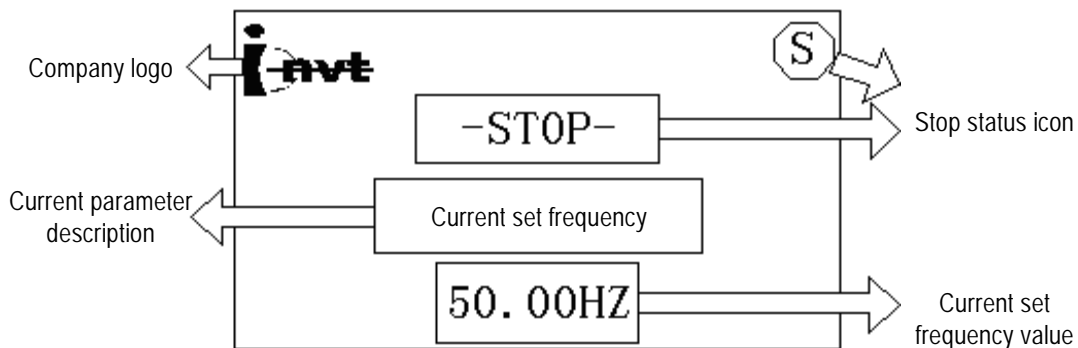

Figure 2.3.3.1 Standard Stop State Interface

This is the standard interface for the stop state. It is similar to the standard operation state interface. The differences are: it has a STOP icon, but the standard operation state interface has a RUN icon; the description of current parameter changes to “Current operating frequency”; the last line displays “Current operating frequency value”.

To view other parameters in the Stop (or operation) state, press `<>>/SHIFT >`. The interface will display three parameters at the same time, as shown in the figure below:

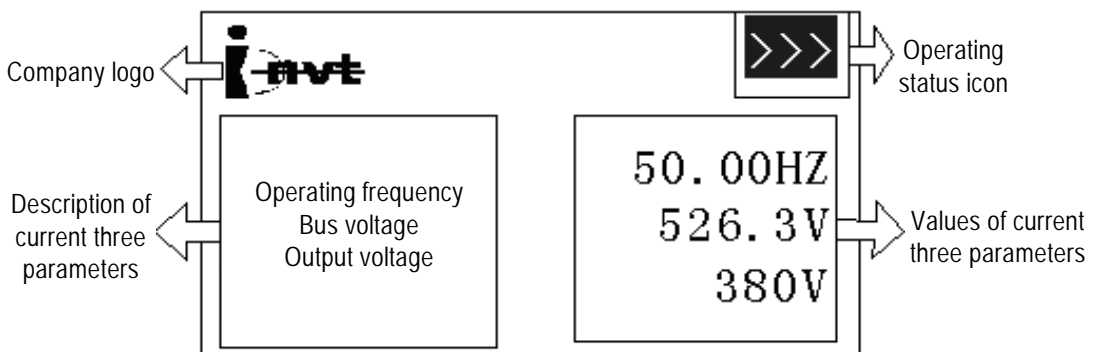

Figure 2.3.1.2 Interface Displaying Three Parameters

Only when parameters P7.06 and P7.07 are correctly set can a user view required parameters in the Stop or Operation state.

Note:

In the operation state, if the operation direction of the motor is reverse to the set direction, the operation state icon in the above figure will be in a reverse direction. This icon takes effect at the same time as the FWD/REV LED.

2.3.2 Level-1 Menu Interface

To enter level-1 menu, press <PRG/ESC> in the Stop or Operation state. Press <PRG/ESC> again, the system exits the level-1 menu and returns to the previous state.

In the level-1 menu, press <▲> or <▼> to search the required group number. Press <DATA/ENT> to enter level-2 menu.

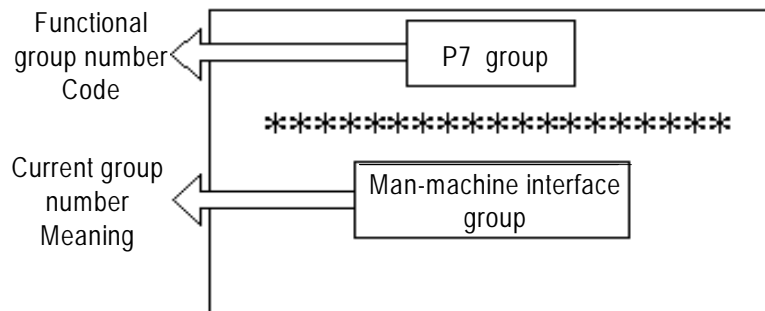

Figure 2.3.2 Interface of Level-1 Menu

2.3.3 Level-2 Menu Interface

Perform the proceeding operation to enter the level-2 menu. In the level-2 menu, press <PRG/ESC> to return to the level-1 menu; press <DATA/ENT> to enter level-3 menu. If the user presses <QUICK/JOG> in the level-2 menu, the system enters the shortcut menu saving confirmation interface. Likewise, by pressing <▲> or <▼> in the level-2 menu, the user can search up or down menu options.

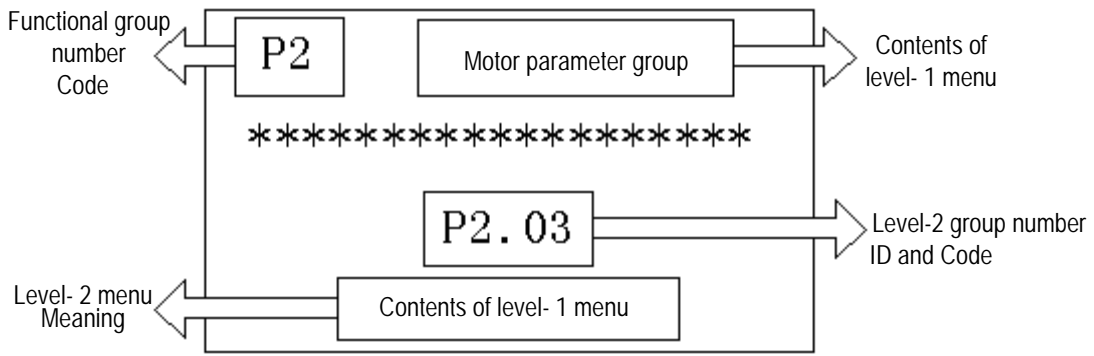

Figure 2.3.3 Interface of Level-2 Menu

2.3.4 Level-3 Menu Interface

In the level-3 menu, press <PRG/ESC>, the system returns to the level-2 menu; press <DATA/ENT>, the system saves the parameter content in the level-3 menu after confirmation. Likewise, by pressing <▲> or <▼> in the level-3 menu, the user can search up or down menu options. Where, if the serial number of a parameter flickers, it indicates that the serial number of the parameter can be modified. The serial number of a parameter consists of two bits (only one bit is flickering). The user can select the bit to be modified by the <>>/SHIFT> key. The following figure shows the level-3 menu for parameter selection.

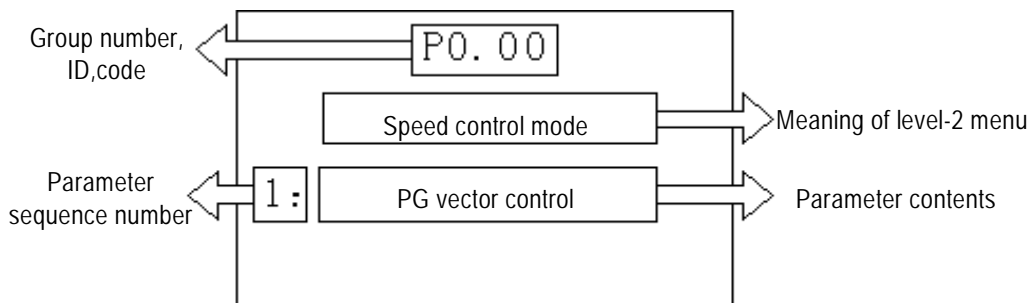

Figure 2.3.4 Interface of Level-3 Menu

The level-3 menu for parameter modification is similar to that for parameter selection. The difference is that the line for parameter serial number and content displays the parameter value. The user can use the <▲> or <▼> key to modify a flickering digit, and can use the <>>/SHIFT> key to shift the modification position from left to right. During position shift, the decimal point will be automatically overlapped.

Note:

In a level-3 menu, if no bit of the serial number of a parameter flickers, it indicates that the parameter cannot be modified. Check whether it is caused by the operating state of the inverter, or it is a read-only parameter.

2.3.5 Fault Status Interface

If a fault occurs with the inverter, the display screen will immediately switch to the fault display interface to show the fault, no matter what interface it is. The interface of fault display is as follows:

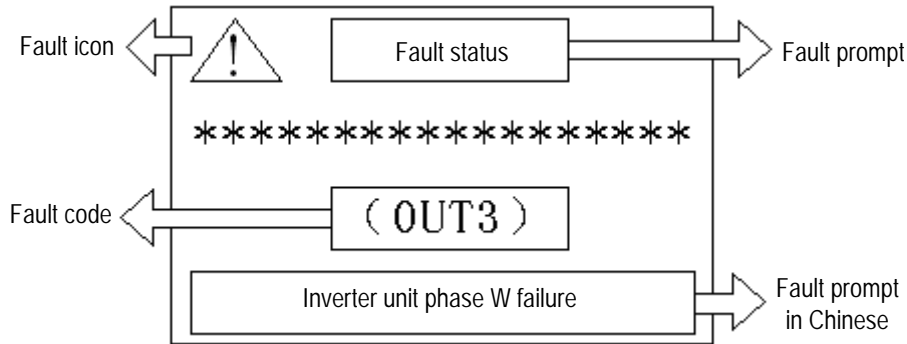

Figure 2.3.5 Interface of Fault Status

After the fault is removed, it is necessary to press <STOP/RST> to perform fault reset. Fault reset state can be selected in the P5 group of parameters. For details, refer to fault reset section (5.2.3) in Operating Instructions for CHV Series Vector Inverters.

2.3.6 Shortcut Menu Interface

The interfaces of shortcut menus are similar to normal level-2 or level-3 menus. To distinguish them from each other, functional parameter group number and ID are in square brackets. If a functional code is in the square brackets, it indicates it is in the shortcut menu mode. For details, refer to the section Operations on Shortcut Parameters (5.2.2.2) in the operating instructions.

Note:

The CHE series do not have such shortcut menu.

3. LCD Screen Contrast Adjustment

If the user finds that the contrast of the display screen is low, the user can remove the back cover of the external LCD keypad and adjust the potentiometer for internal contrast adjustment. The direction shown in the figure below is to increase the contrast.

Note:

Users are recommended not to adjust the contrast by themselves lest it may void the warranty. The contrast has been adjusted to an optimal level when the equipment is delivered out of the factory.

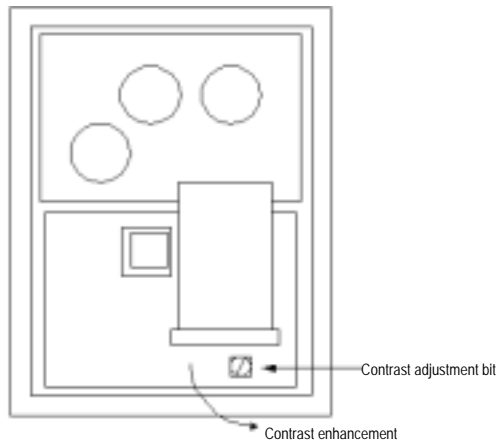

4. Installation Dimensions of External LCD Keypad

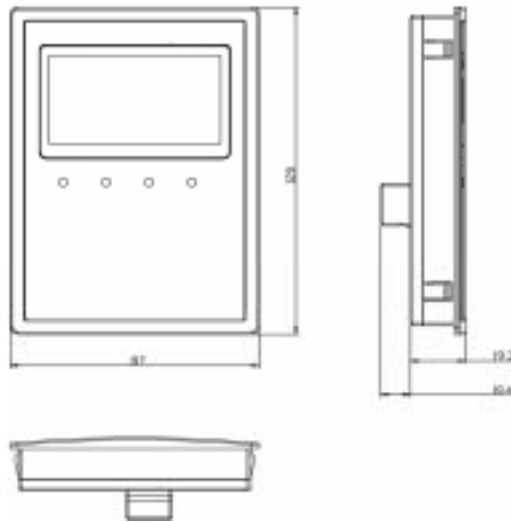

Figure 4-1 Installation Dimensions of External LCD Keypad

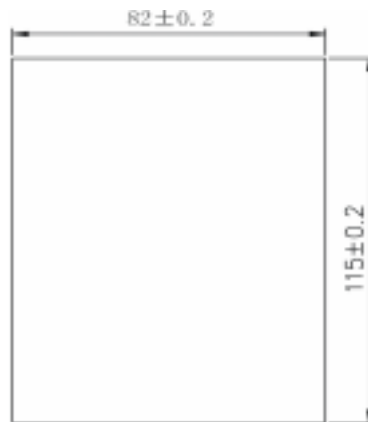

Figure 4.2 Hole Size of External LCD Keypad